

SDT2-40
09150210
SCL=1/5

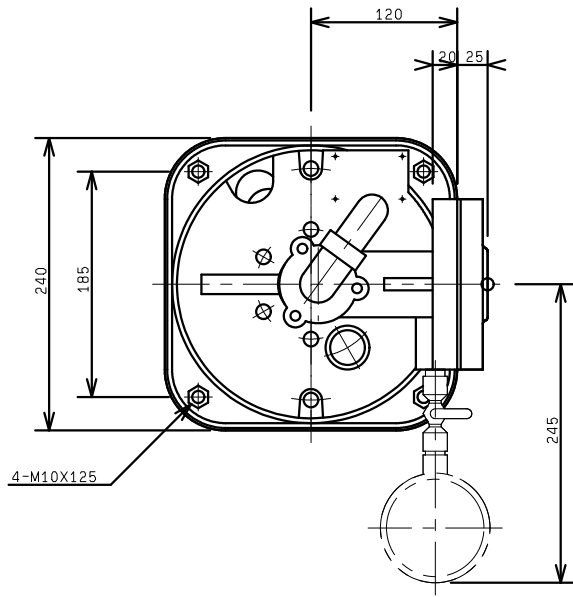

平面図

上面



上面

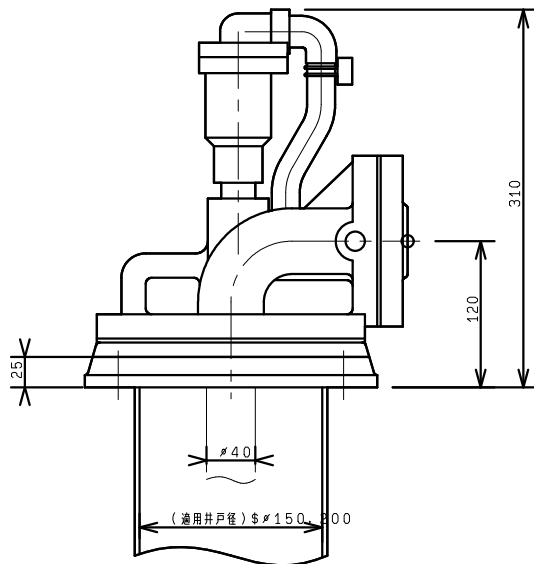

正面図

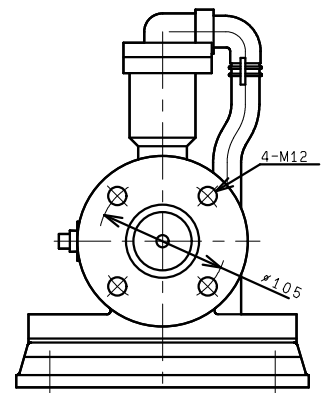

右側面図

