

SDT2-25 (バルブ付)
09150910
SCL = 1/5

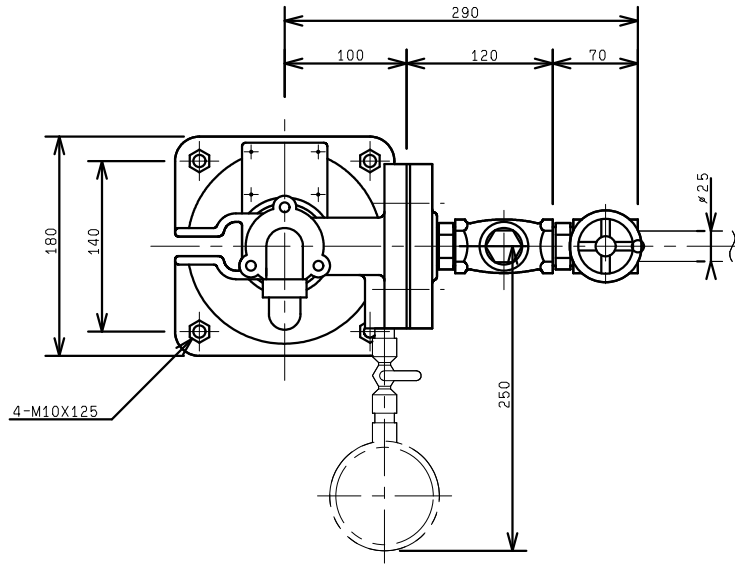

平面図

上面

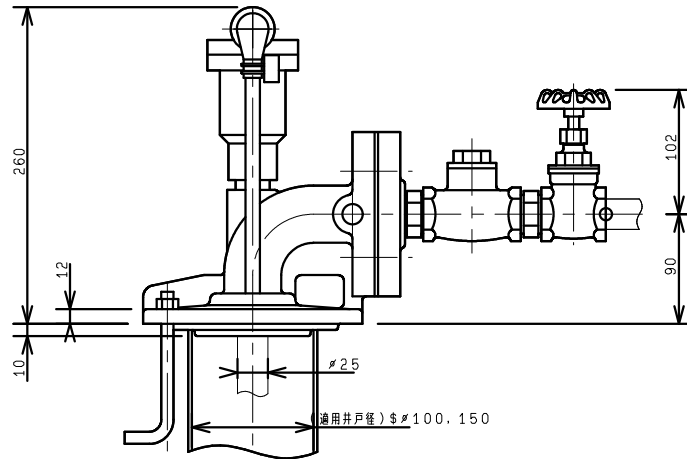

正面図