

SDT2-25
09150910
SCL=1/5

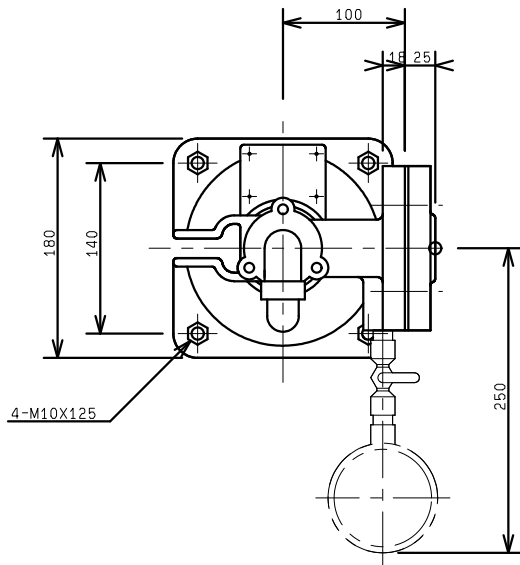

平面図

上面



上面

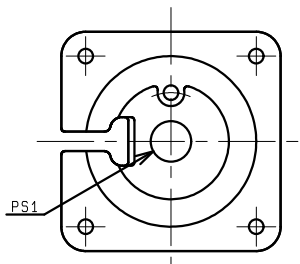
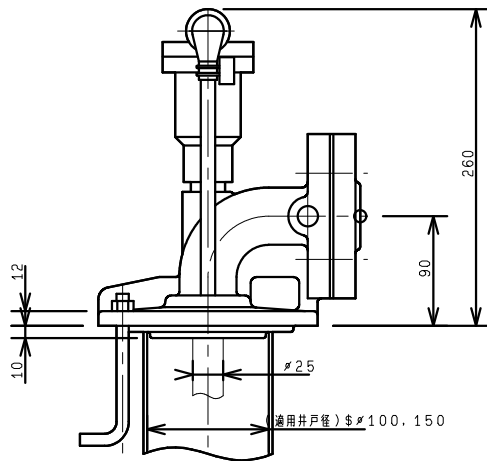

正面図

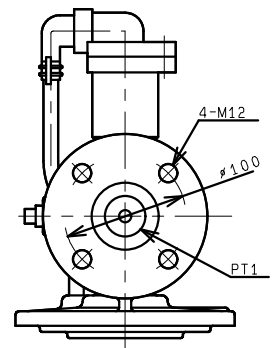

右側面図