

SDT-SN50

09160610

SCL=1/5

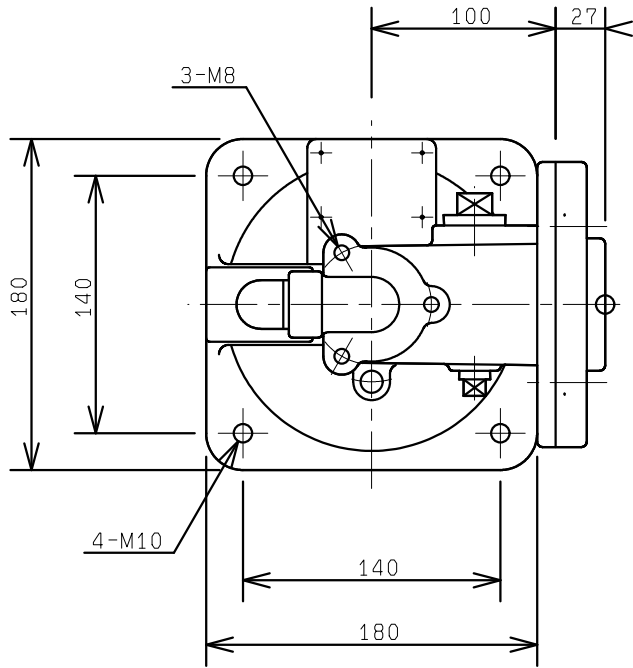

平面図

上面

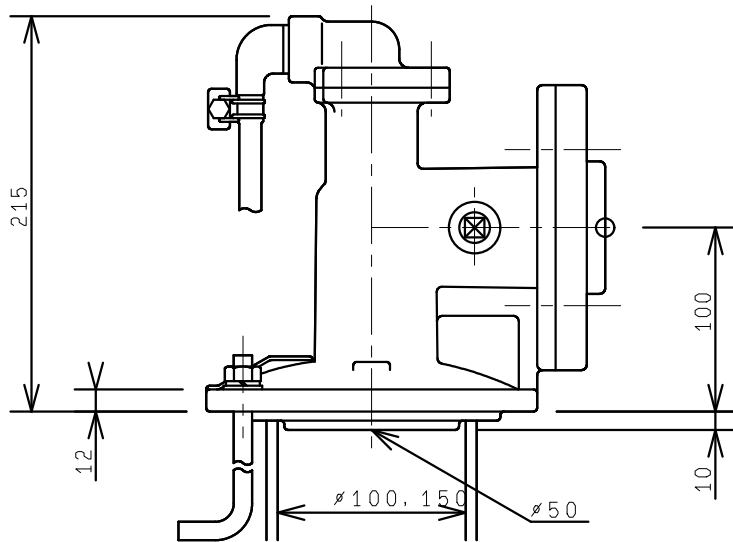

正面図

上面

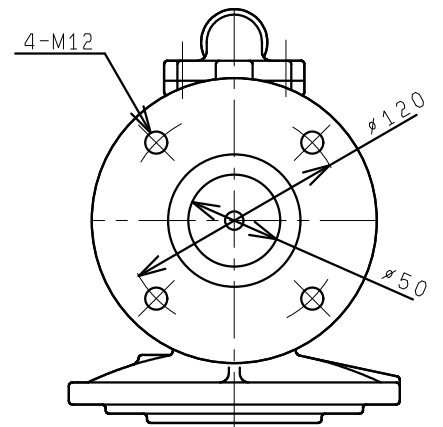

右側面図