

SDT-S50

09151410

SCL=1/5

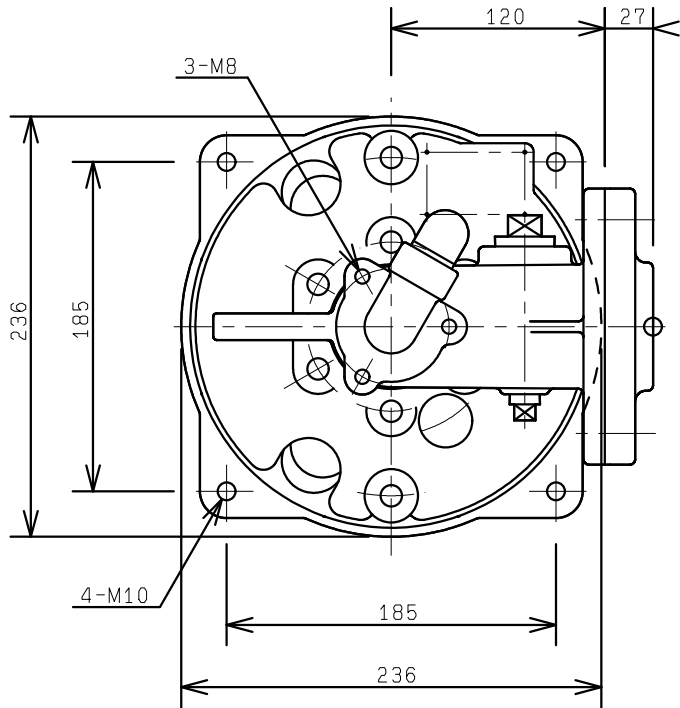

平面図

上面

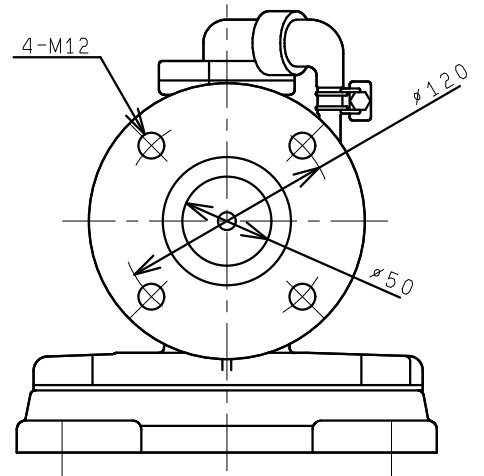

上面

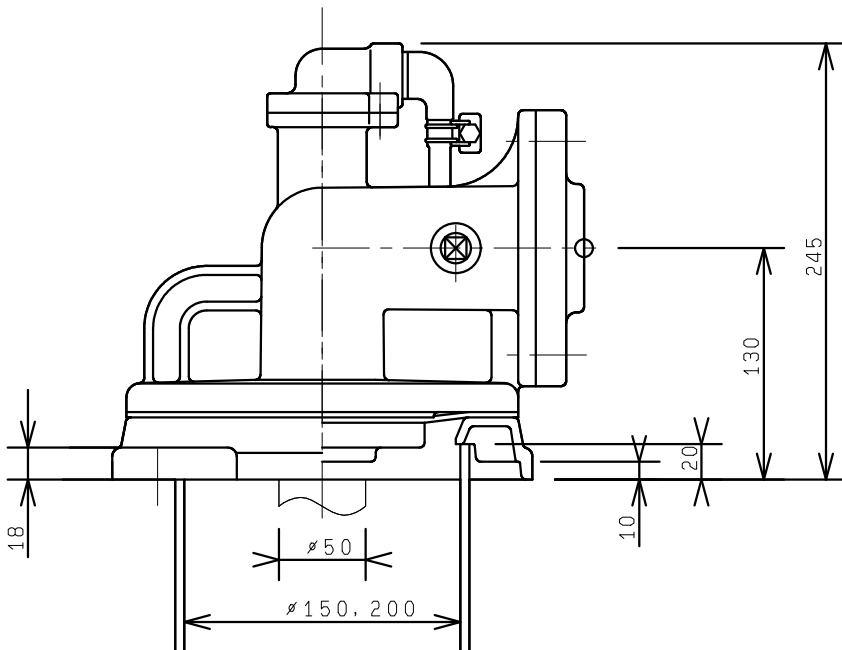

正面図

右側面図