

# PJR-37

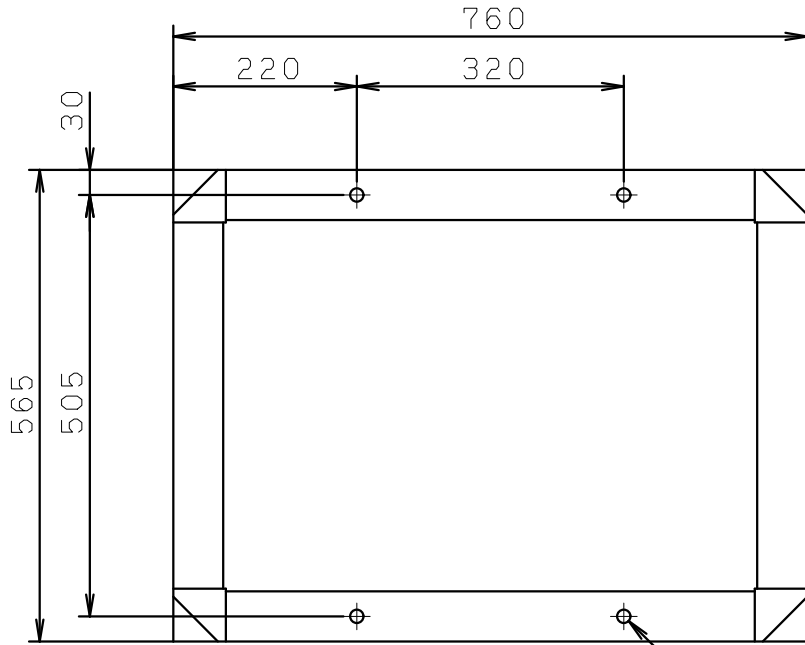

4- $\phi$ 16 (ポンプ取付穴)

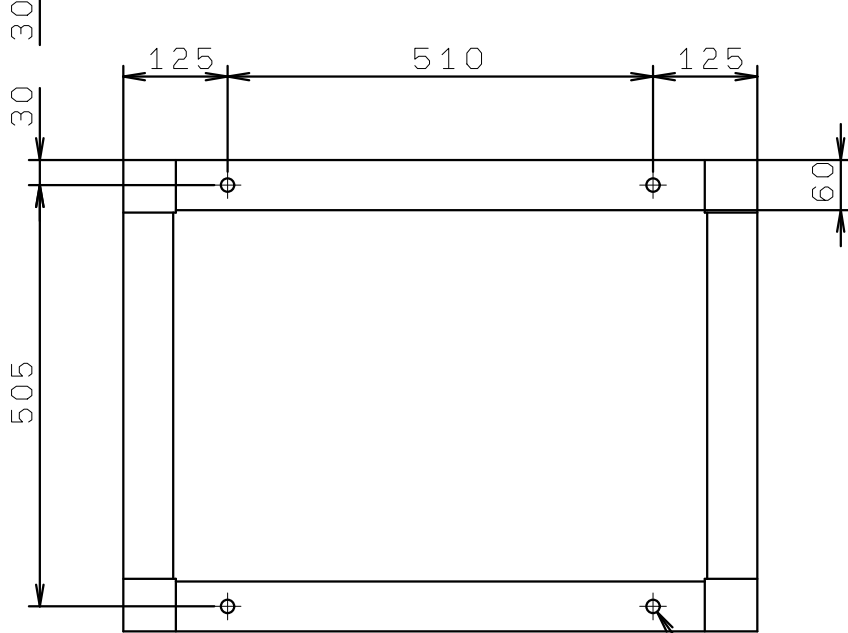
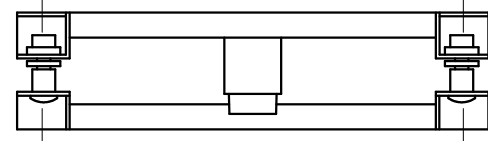
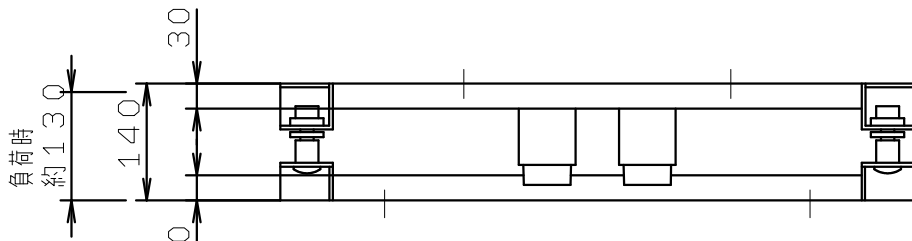

4- $\phi$ 16 (基礎ボルト取付穴)