

KB2-505AE3.7
 KB2-506AE3.7
 (VC81)

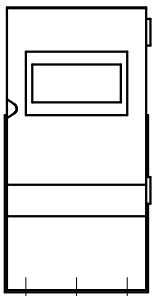

(制御盤正面図)

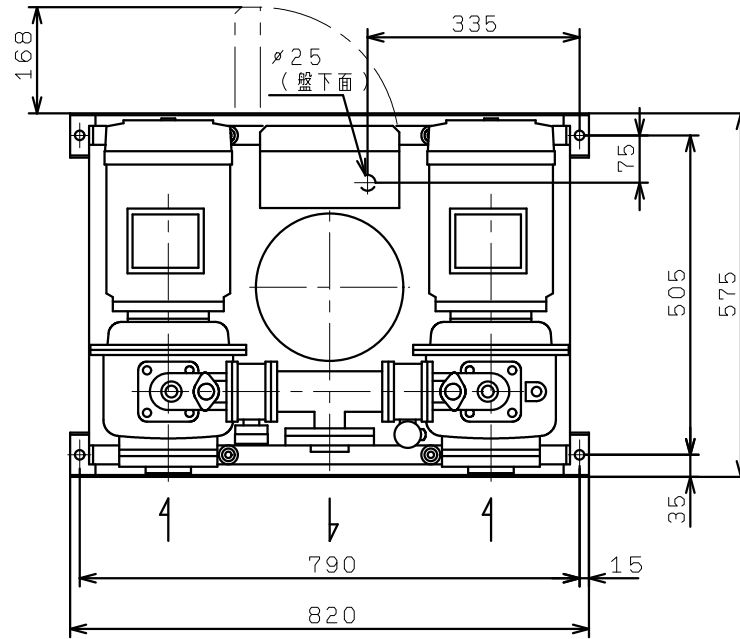