

KB2-505AE3.7
 KB2-506AE3.7
 (標準, VC40, 94)

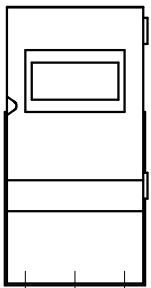

(制御盤正面図)

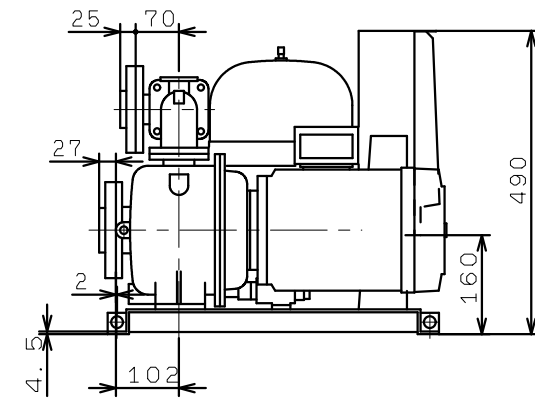
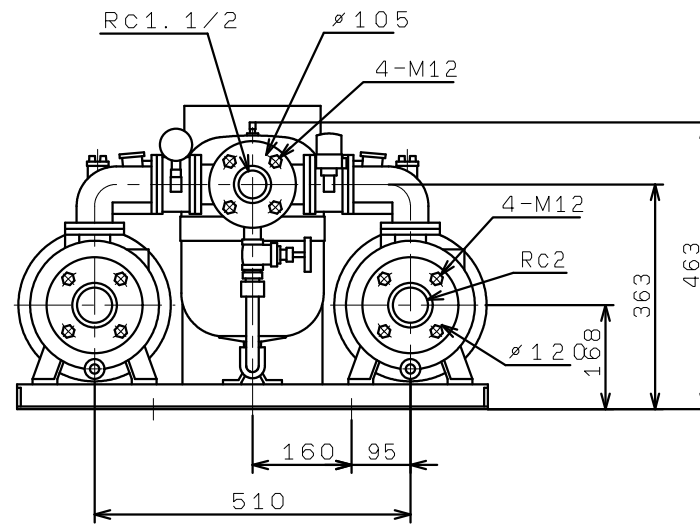
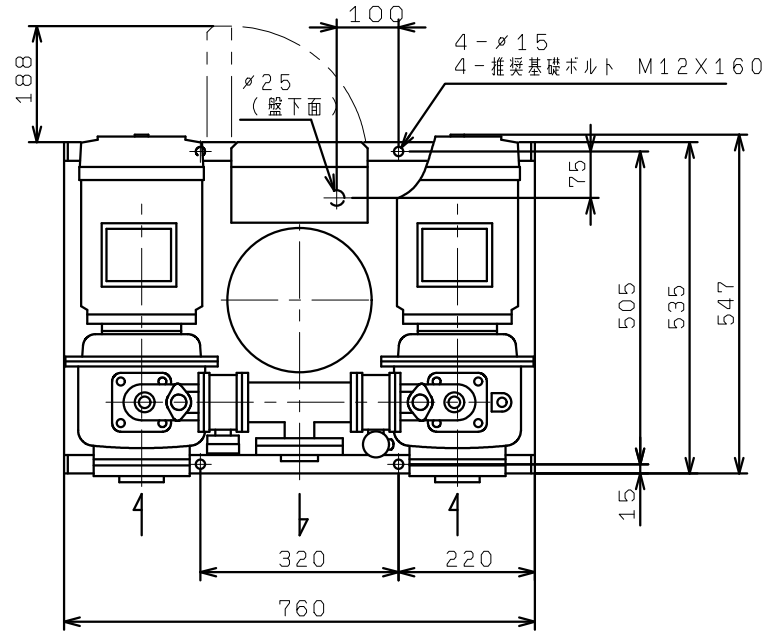