

KB2-505AE1.5
 KB2-506AE1.5
 (VC81)

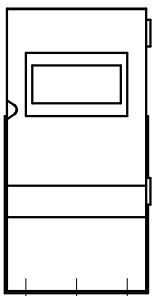

(制御盤正面図)

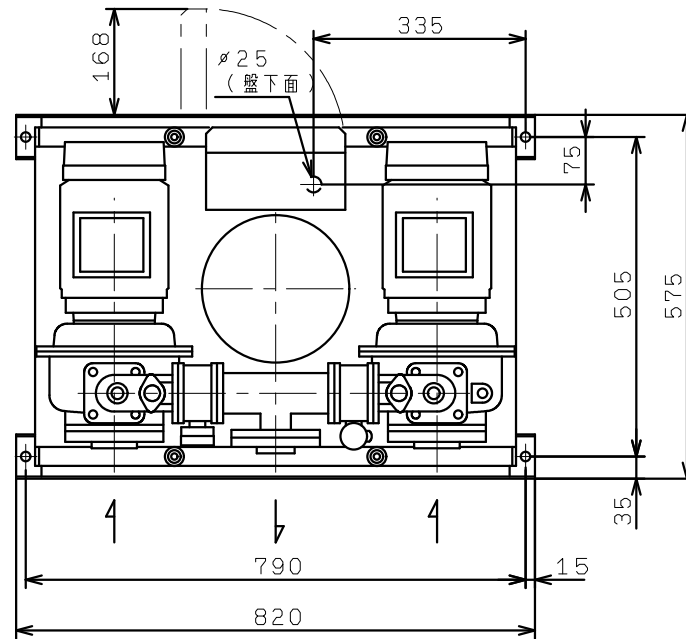