

KB2-506SE2.2

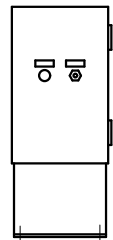
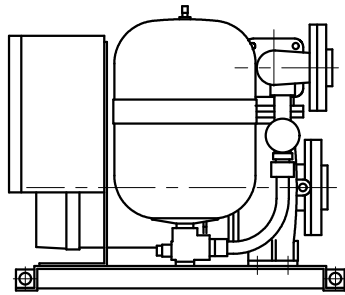
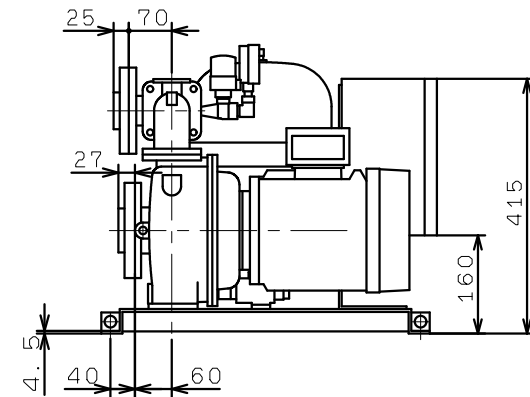
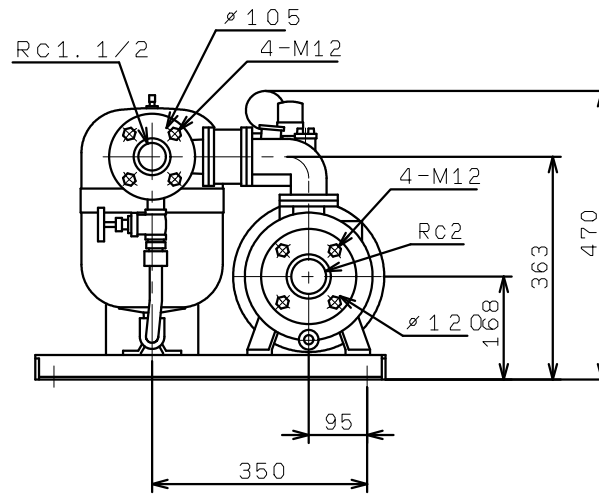
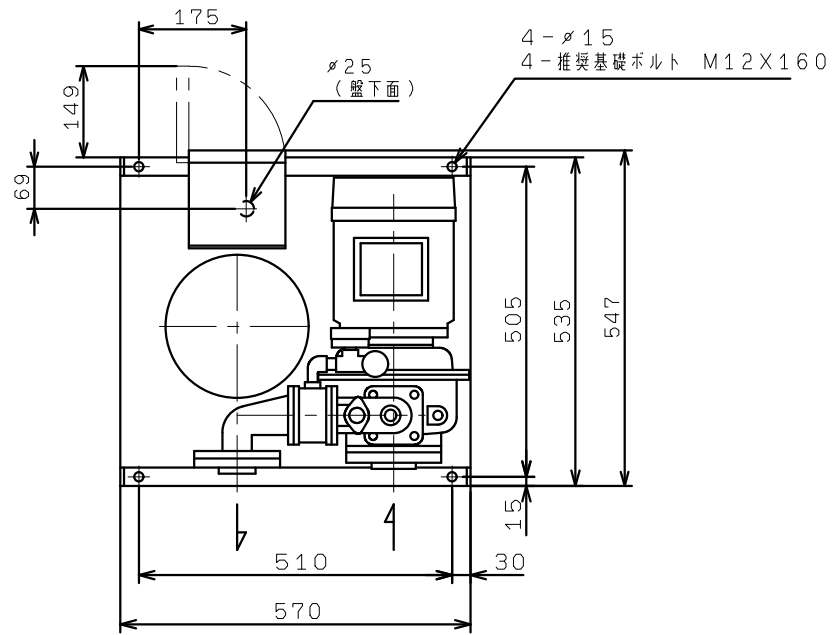

(制御盤正面図)