

KB2-506AE2.2
 (VC41,42,43,44,47)

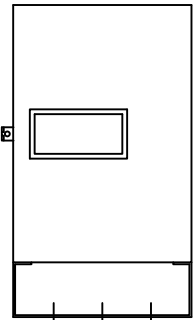

(制御盤正面図)

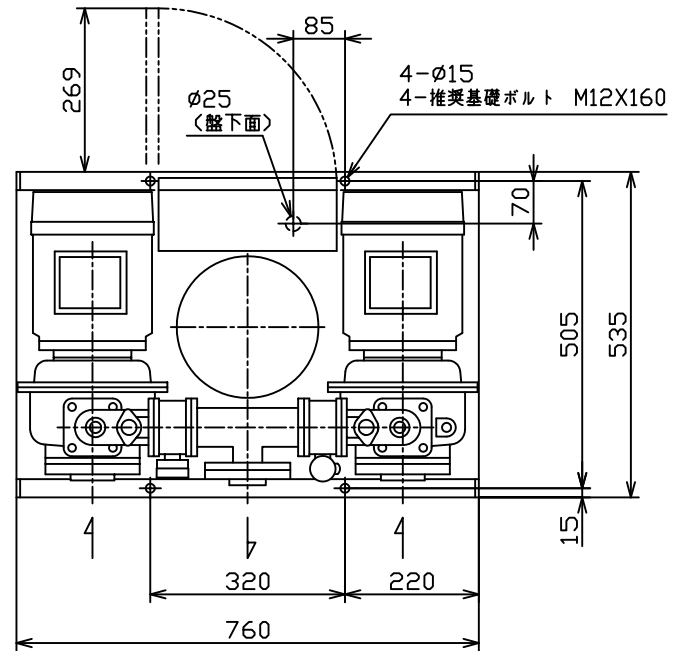