

KB2-505SE2.2
(VC41)

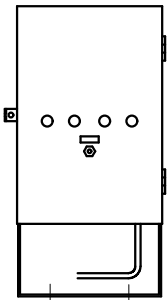

(制御盤正面図)

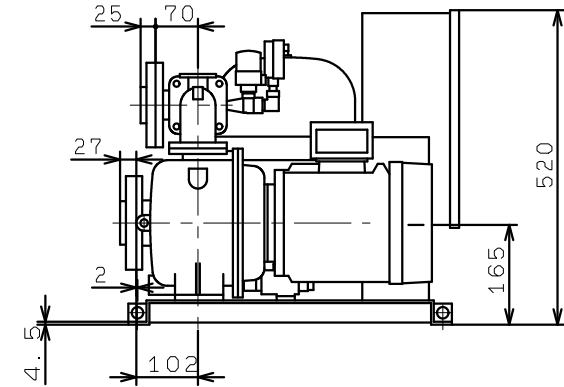
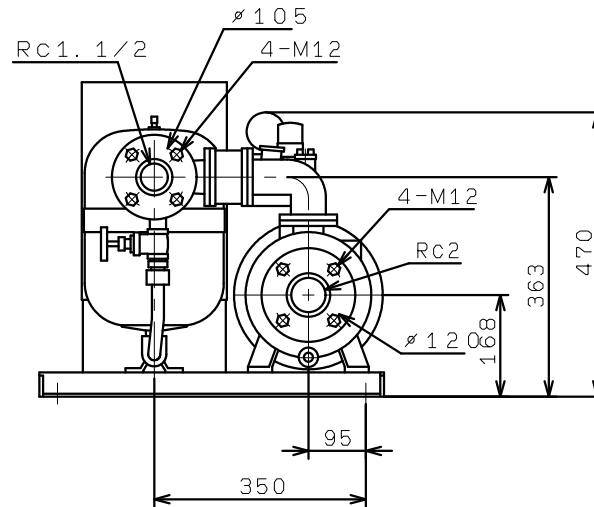
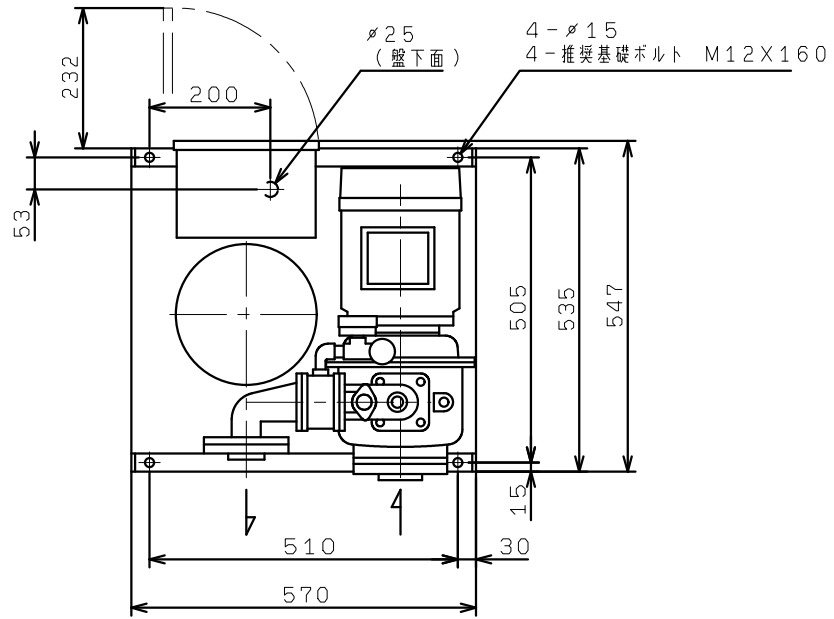