

KB2-505AE2.2
 (標準, VC40, 94)

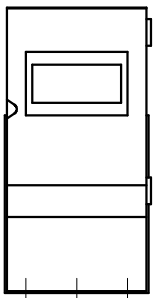

(制御盤正面図)

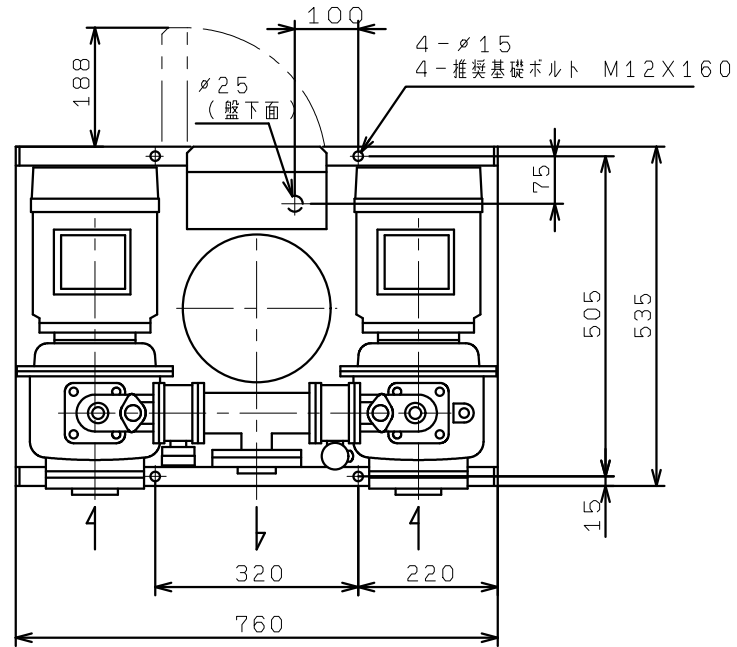