

KB2-405SE2.2
 KB2-406SE2.2
 (VC42, 43, 44)

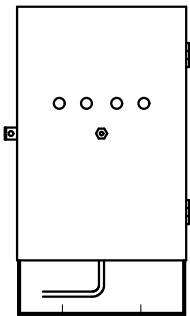

(制御盤正面図)

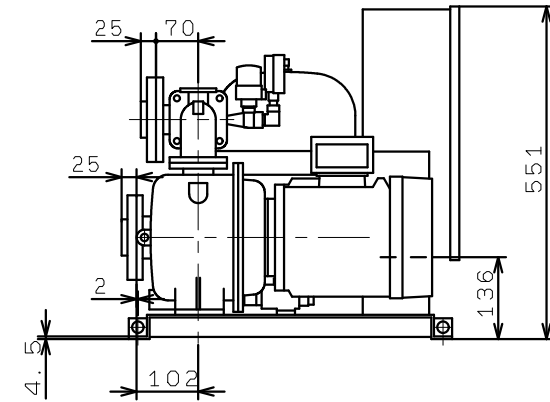
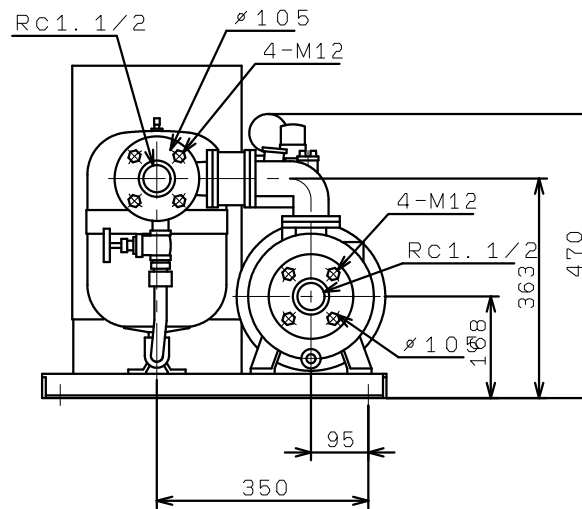
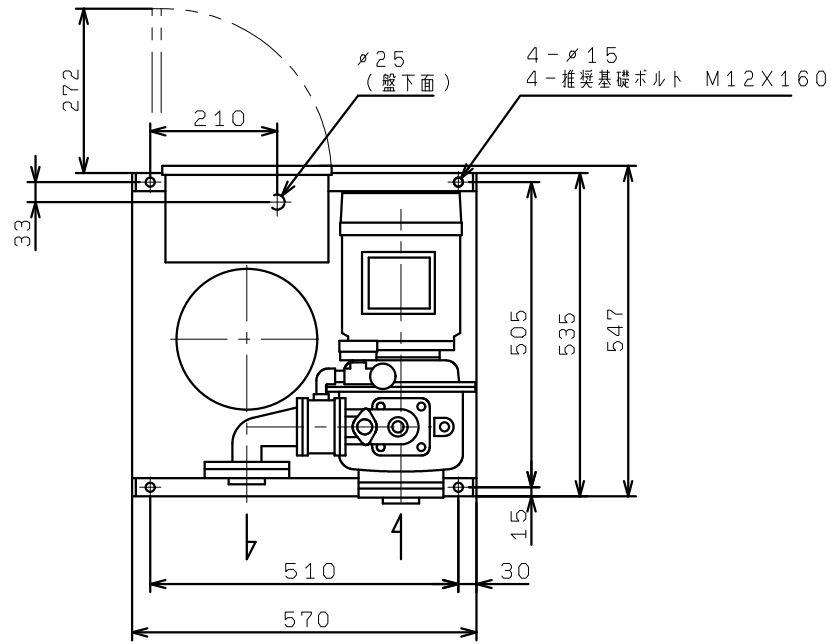