

KB2-405SE2.2
 KB2-406SE2.2
 (VC41)

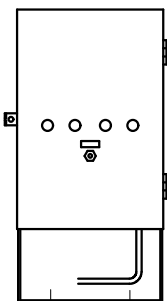

(制御盤正面図)

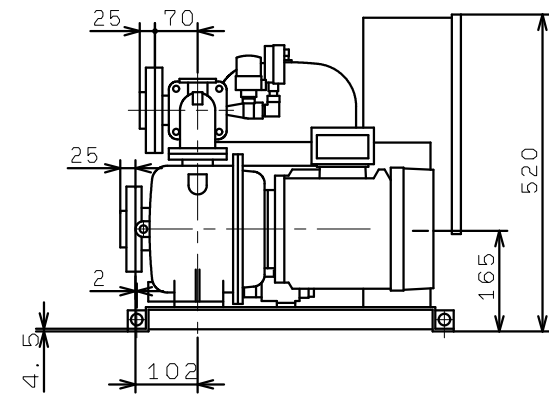
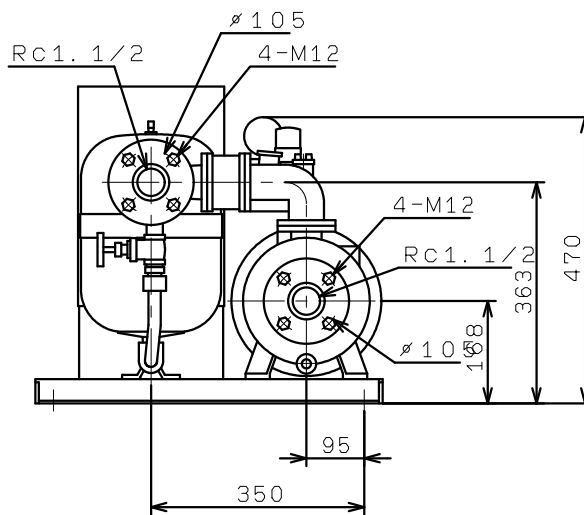
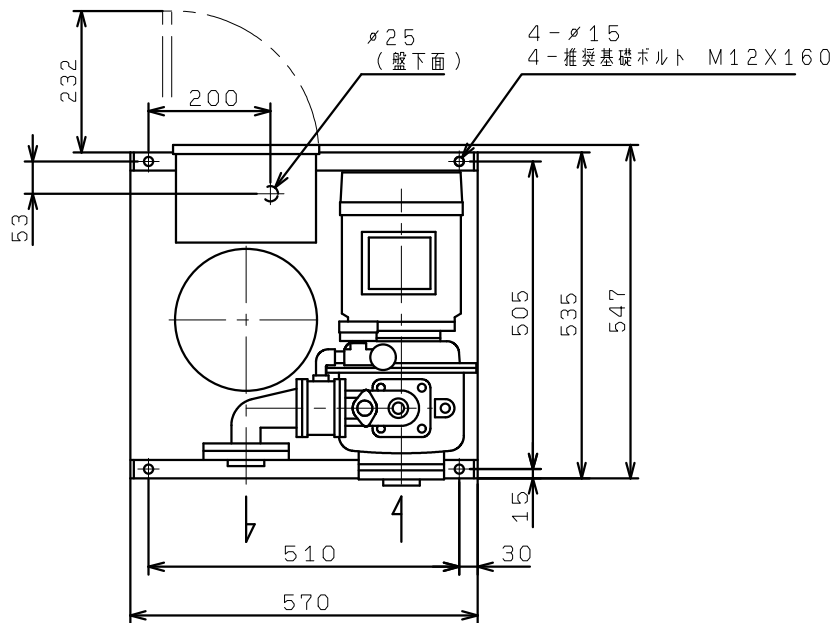