

KB2-405SE2.2
KB2-406SE2.2

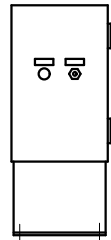
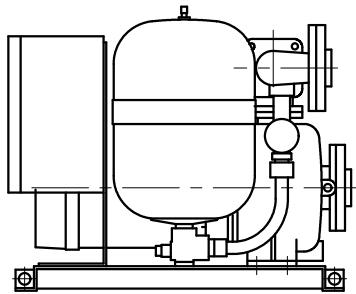
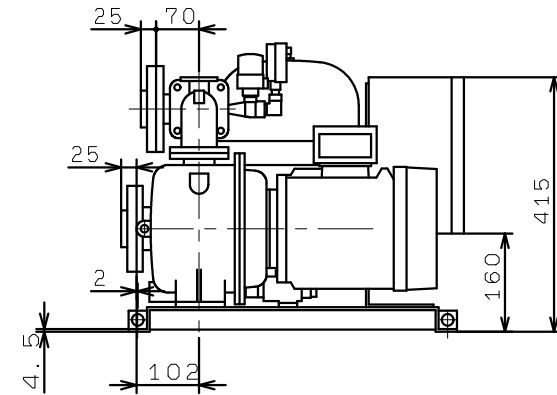
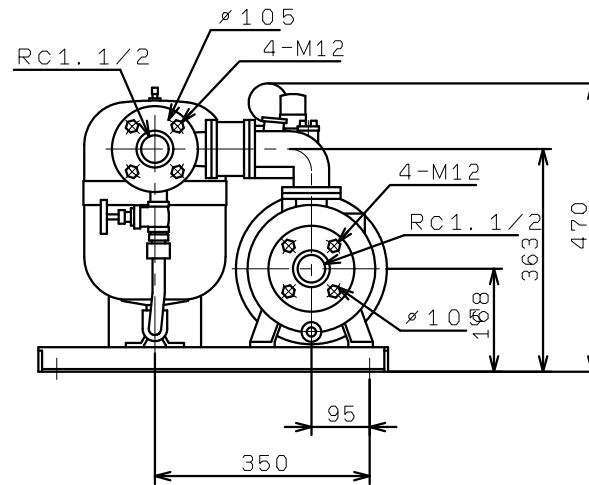
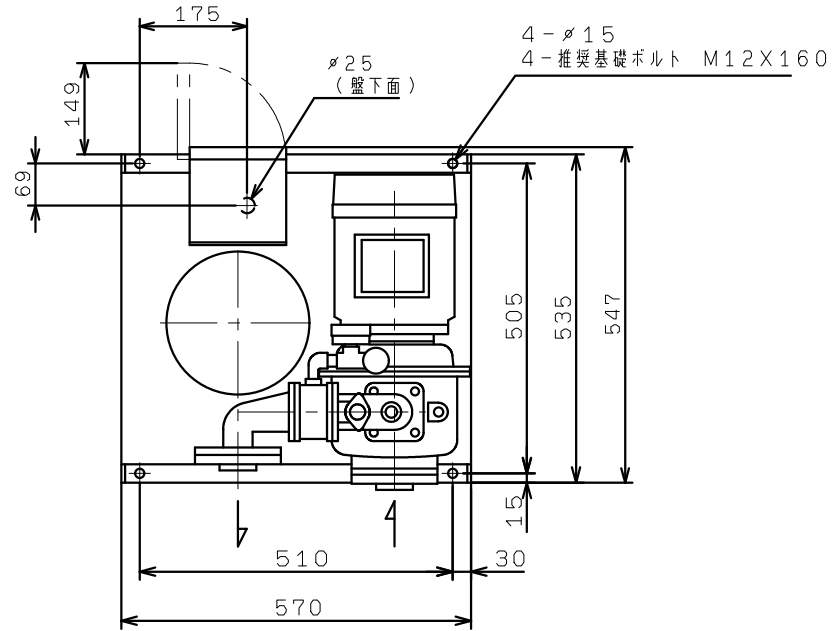

(制御盤正面図)