

KB2-405PE2.2
 KB2-406PE2.2
 (VC41, 42, 43, 44, 47)

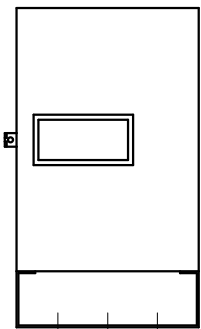

(制御盤正面図)

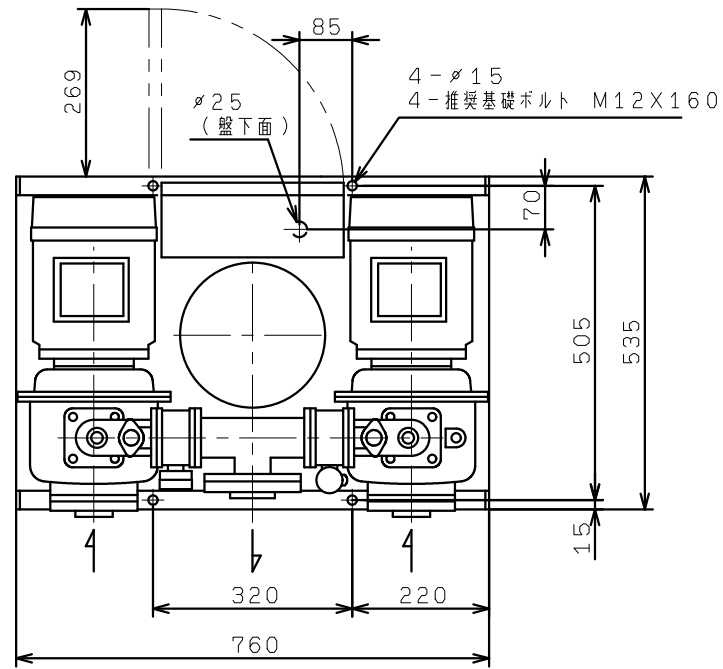