

KB2-405AE1.5
 KB2-406AE1.5
 (VC81)

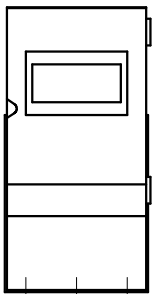

(制御盤正面図)

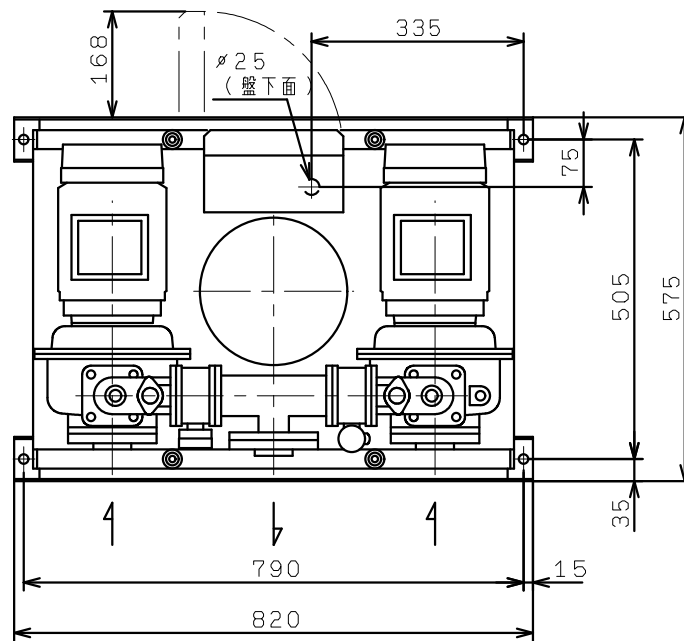