

KB2-405AE1.5
 KB2-406AE1.5
 (VC41, 42, 43, 44, 47)

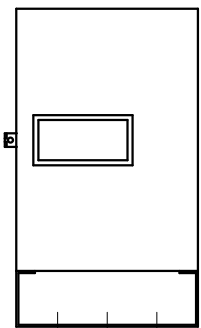

(制御盤正面図)

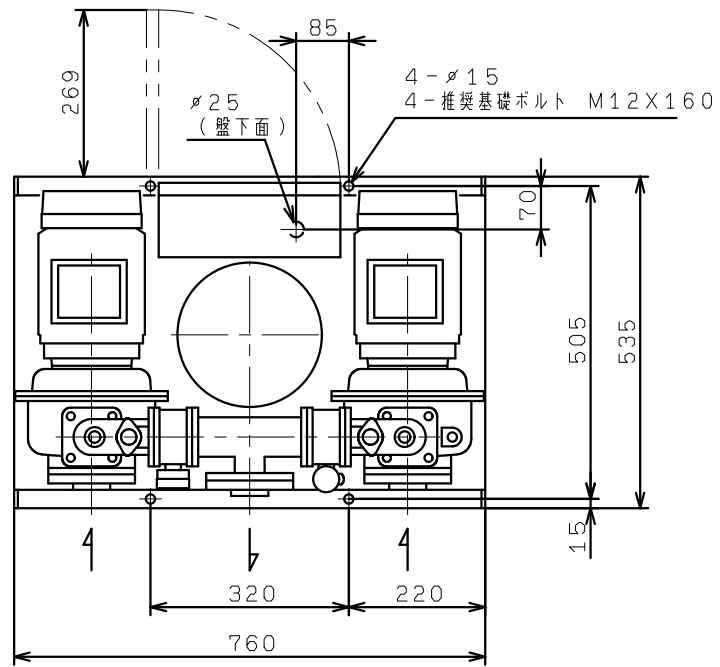