

KB2-325PE0.75
 KB2-326PE0.75
 (標準, VC40, 94)

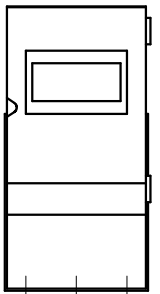

(制御盤正面図)

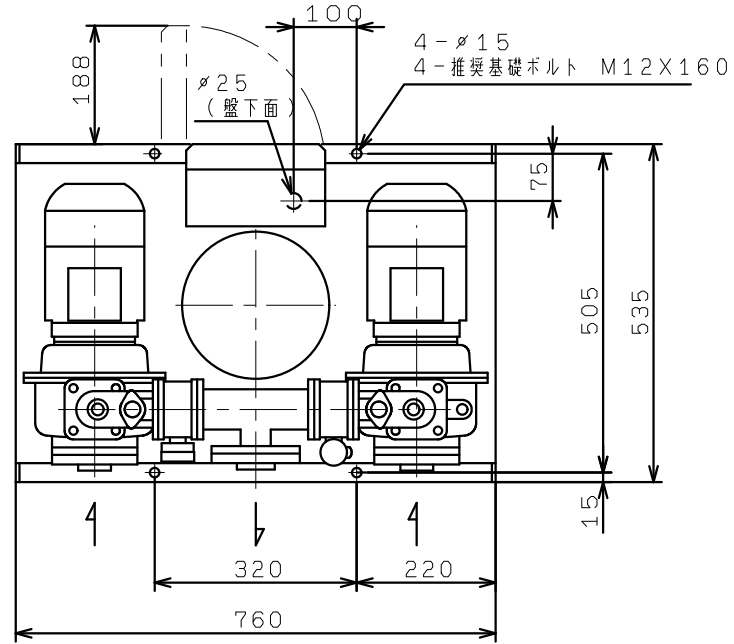