

KB2-325AE0.75  
 KB2-326AE0.75  
 (VC41, 42, 43, 44, 47)

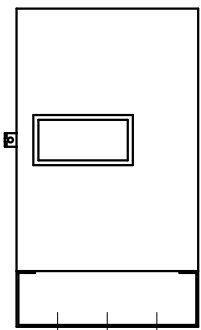

(制御盤正面図)

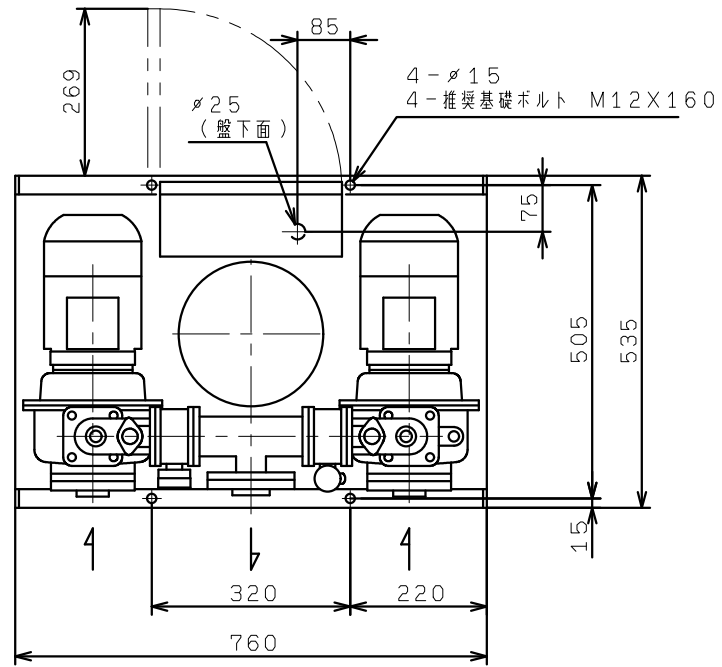