

KB2-326SE1.1
(VC41)

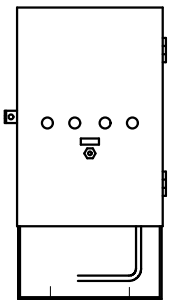

(制御盤正面図)

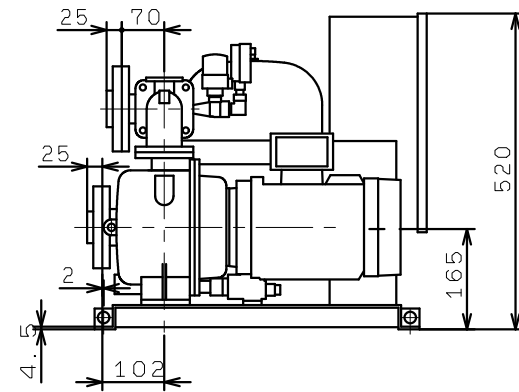
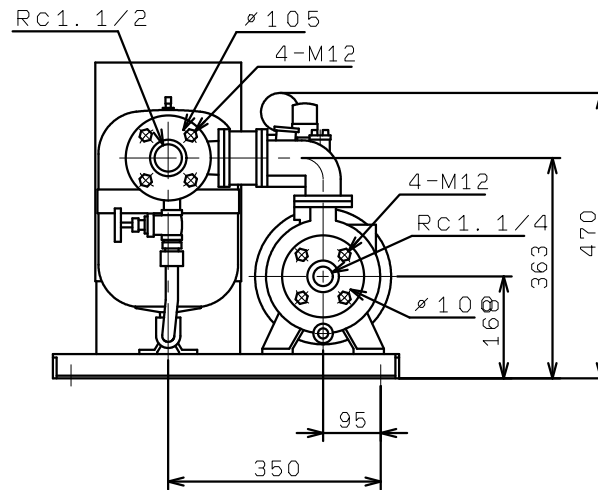
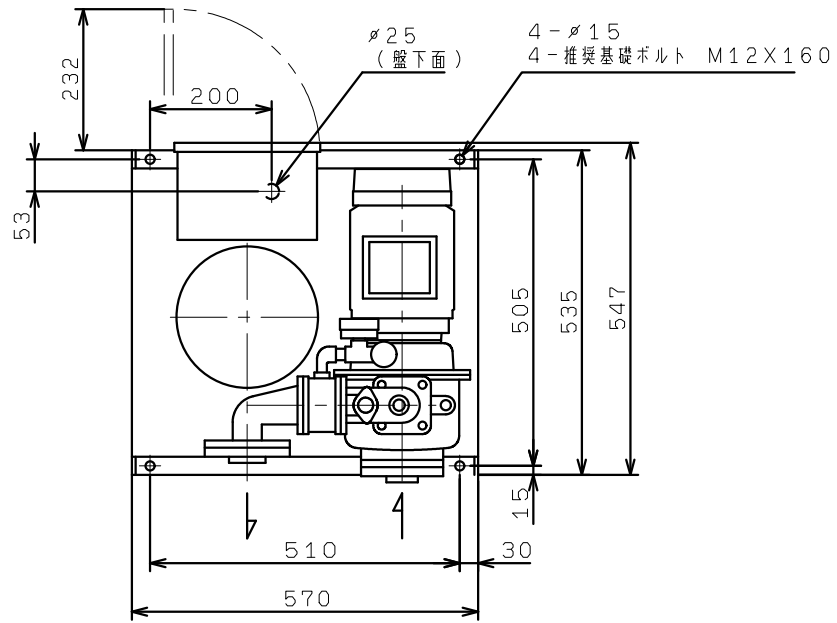