

KB2-326AE1.1
(VC81)

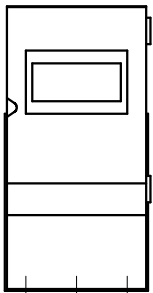

(制御盤正面図)

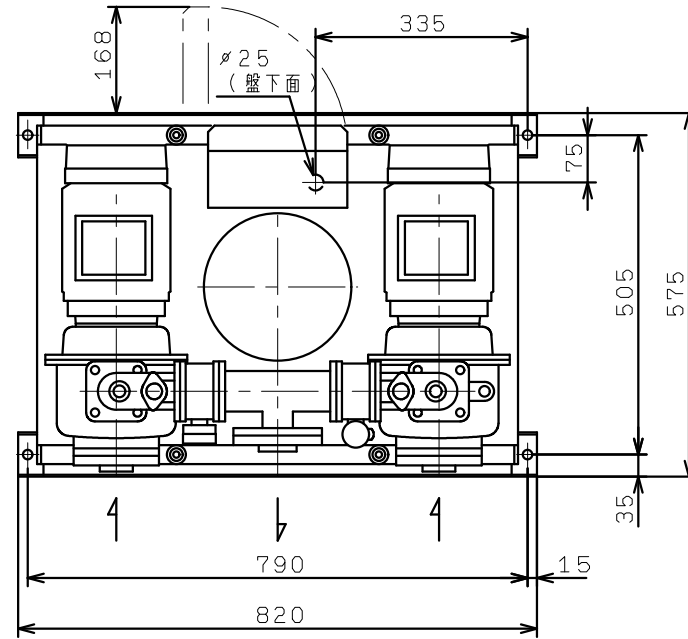