

KB2-325SE1.1  
(VC41)

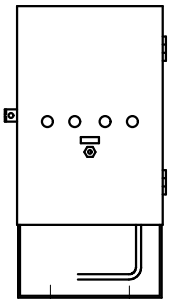

(制御盤正面図)

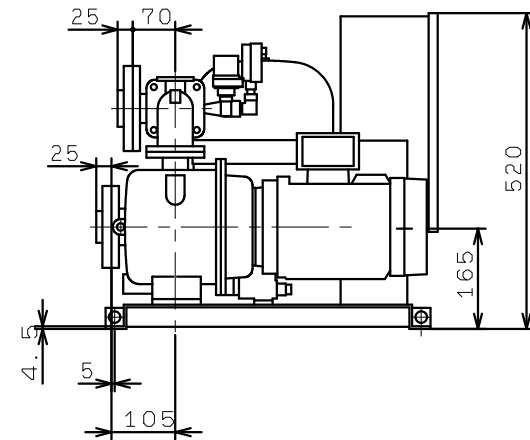
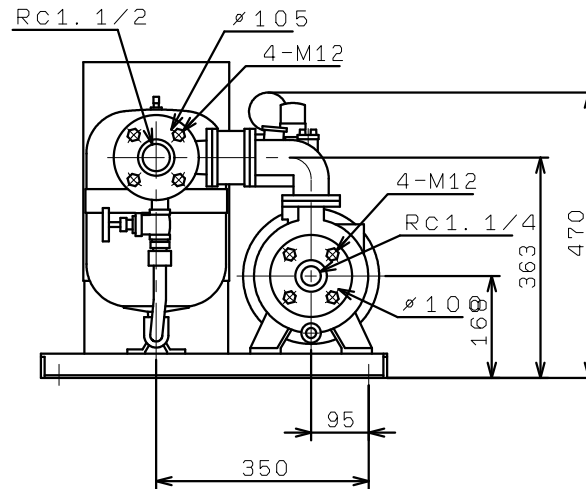
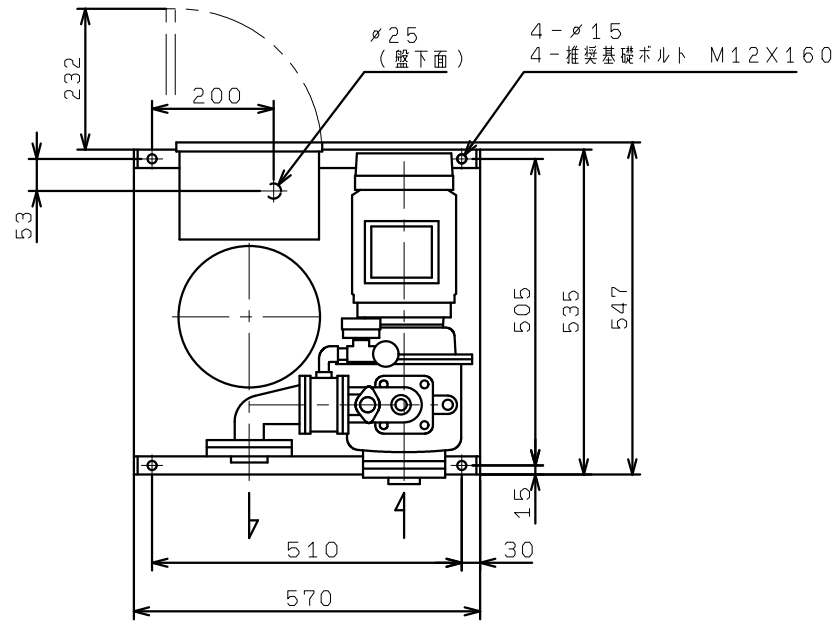