

FV01505-4C30
FV01505-4C30T4

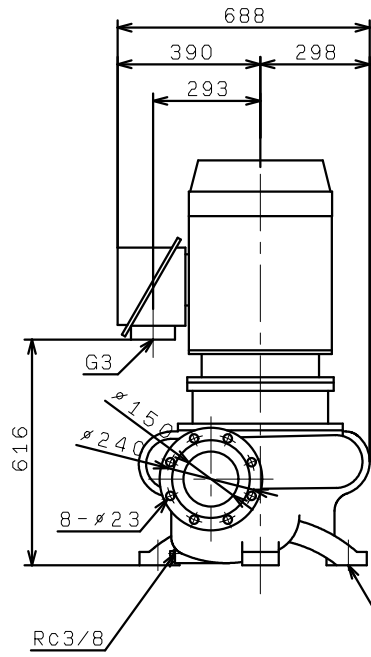

4- $\phi 23$
4-推奨基礎ボルト M20X250*

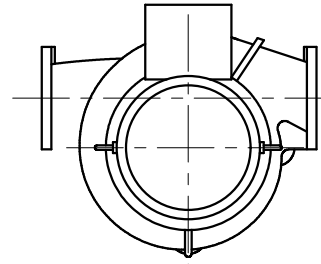