

FVDM2005-4C22
 FVDM2005-4C22T4

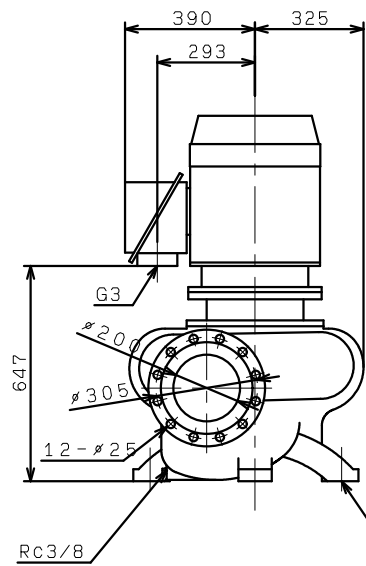

4- $\phi 23$
 4-推奨基礎ボルト M20X250※

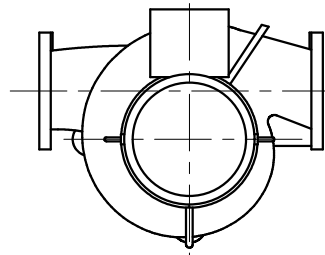